

**Huawei FusionServer 2488H V5
V100R005**

Technical White Paper

Issue 01
Date 2019-04-05



Copyright © Huawei Technologies Co., Ltd. 2019. All rights reserved.

No part of this document may be reproduced or transmitted in any form or by any means without prior written consent of Huawei Technologies Co., Ltd.

Trademarks and Permissions



HUAWEI and other Huawei trademarks are trademarks of Huawei Technologies Co., Ltd.

All other trademarks and trade names mentioned in this document are the property of their respective holders.

Notice

The purchased products, services and features are stipulated by the contract made between Huawei and the customer. All or part of the products, services and features described in this document may not be within the purchase scope or the usage scope. Unless otherwise specified in the contract, all statements, information, and recommendations in this document are provided "AS IS" without warranties, guarantees or representations of any kind, either express or implied.

The information in this document is subject to change without notice. Every effort has been made in the preparation of this document to ensure accuracy of the contents, but all statements, information, and recommendations in this document do not constitute a warranty of any kind, express or implied.

Huawei Technologies Co., Ltd.

Address: Huawei Industrial Base
Bantian, Longgang
Shenzhen 518129
People's Republic of China

Website: <http://e.huawei.com>

Contents

1 Overview.....	1
2 Features.....	3
3 Logical Structure.....	6
4 Hardware Description.....	8
4.1 Appearance.....	8
4.2 Ports.....	9
4.3 Indicators and Buttons.....	13
4.4 PCIe Slots.....	19
4.5 Physical Structure.....	22
5 Product Specifications.....	25
5.1 Technical Specifications.....	25
5.2 Physical Specifications.....	30
6 Component Compatibility.....	34
6.1 CPU.....	34
6.2 Memory.....	34
6.3 Storage.....	40
6.4 I/O Expansion.....	43
6.5 PSU.....	47
6.6 OS and Software Support.....	48
7 System Management.....	49
8 Warranty.....	52
9 Certifications.....	53
10 Nameplate Models.....	56

1 Overview

The Huawei 2488H V5 is a 2U 4-socket rack server developed for Internet data center (IDC), cloud computing, enterprise, and telecom service applications.

NOTE

For details about the nameplate models, see [Nameplate Models](#).

The 2488H V5 combines high-performance computing (HPC) with large storage capacity, low power consumption, high scalability and reliability, high virtualization application density, and is easy to deploy and manage. It is ideal for various application scenarios, such as database, cloud computing, virtualization, and memory computing application scenarios.

The 2488H V5 supports the following configurations:

- 8 SAS/SATA drives
The server supports a maximum of eight 2.5-inch front SAS/SATA drives. One standard PCIe RAID controller card is required.
In this configuration, the server supports an optional front module, which can be an DVD drive or LCD. The optional front module provides a VGA port and a USB 3.0 port at the front.
- 25 SAS/SATA drives
The server supports a maximum of twenty-five 2.5-inch front SAS/SATA drives. One standard PCIe RAID controller card is required.
- 24 SAS/SATA drives (pass-through)
The server supports a maximum of twenty-four 2.5-inch front SAS/SATA drives. Three standard PCIe RAID controller cards are required. Each RAID controller card is directly connected to eight drives.
- 24 NVMe SSDs
The server supports a maximum of twenty-four 2.5-inch front NVMe SSDs. Two NVMe adapters are required. Slots 0 to 3 can be configured with 2.5-inch SAS/SATA drives. In this case, two NVMe adapters and one plug-in PCIe RAID controller card need to be configured.
- 16 SAS/SATA drives + 8 NVMe SSDs
The server supports a maximum of sixteen 2.5-inch front SAS/SATA drives with one standard PCIe RAID controller card required, and supports a maximum of eight 2.5-inch front NVMe SSDs with two NVMe adapters required. Each adapter supports four NVMe SSDs.

Figure 1-1 Appearance of the 2488H V5 (8 drives)



2 Features

Performance and Scalability

The 2488H V5 offers the following features to boost performance and improve scalability:

- Intel® Xeon® Scalable processors (Skylake, Cascade Lake) ensure high processing performance by providing up to 28 cores, 3.8 GHz frequency, 38.5 MB L3 cache, and three 10.4 GT/s Ultra Path Interconnect (UPI) links between processors. The UPI links enable 4-socket CPU full-mesh topology interconnection, delivering highest processing performance.
 - A 2488H V5 supports four processors, 112 cores, and 224 threads, which maximizes the concurrent execution of multithreaded applications.
 - The layered architecture of the processor cache is optimized to increase the L2 cache capacity. Memory data can be directly processed by the L2 cache, which greatly improves the memory access performance. Each core can exclusively use 1 MB L2 cache, reducing the L3 cache capacity. A single processor can share a maximum of 38.5 MB L3 cache.
 - Intel® Turbo Boost Technology 2.0 enables processor cores to run at maximum speeds during peak hours by temporarily going beyond the processor thermal design power (TDP).
 - Intel® Hyper-Threading Technology enables each processor core to run up to two threads, improving parallel computation capability.
 - Intel® VT-x integrates hardware-level virtualization functions to allow OS vendors to better use hardware to address virtualization workloads.
- Up to 48 DDR4 error checking and correcting (ECC) RDIMMs or load-reduced DIMMs (LRDIMMs) provide a maximum memory speed of 2933 MT/s and a maximum memory capacity of 6144 GB, featuring high speed and availability. The maximum memory bandwidth is 549.9 GB/s in theory (for Cascade Lake CPU only).
- Intel® Advanced Vector Extensions 512 (AVX-512) uses up to two 512-bit fused multiply add (FMA) units to allow an application to achieve 32 double and 64 single-precision floating-point operations, and eight 64-bit and sixteen 32-bit integers in a clock cycle of a 512-bit vector. Compared with Intel® AVX 2.0, AVX-512 doubles the register width, number of registers, and FMA unit width.
- 12 Gbit/s internal SCSI (SAS) storage connection doubles the data transmission rate compared with the 6 Gbit/s SAS storage connection, maximizing the performance of I/O-intensive applications.

- The I/O performance of pure SSDs is higher than that of mixed configuration of SSDs and HDDs or pure HDDs. Compared with a typical HDD, the IOPS of an SSD increases by 100 times.
- The 2488H V5 supports flexible drive configurations and provides elastic and scalable memory capacities to satisfy storage capacity and upgrade requirements.
- The Intel® Xeon® Scalable series processors incorporate the PCIe 3.0 controller using the Intel Integrated I/O. This remarkably shortens I/O latency and enhances overall system performance.
- The 2488H V5 supports up to 11 PCIe 3.0 slots.

Availability and Serviceability

The 2488H V5 provides the following features to improve availability and serviceability:

- The 2488H V5 uses carrier-class components and follows the engineering process, which dramatically improves system reliability.
- The 2488H V5 uses hot-swappable SATA and SAS drives. It supports redundant array of independent disks (RAID) 0, 1, 1E, 10, 5, 50, 6, and 60 and offers RAID cache. A supercapacitor is used to protect RAID cache data from power failures.
- The UID and health indicators, fault diagnosis LED, and touchable LCD diagnosis panel on the panel and the key component status displayed on the iBMC WebUI help technical support personnel quickly locate faulty components or fault risks. This simplifies maintenance, shortens troubleshooting time, and improves system availability.
- SSDs offer better reliability than HDDs, which extends the Mean Time Between Failures (MTBF).
- The Huawei integrated management module (iBMC) monitors system parameters in real time, triggers alarms, and performs recovery actions in case of failures. This helps minimize system downtime.
- Huawei provides a three-year warranty for parts replacement and limited onsite repair for the servers used in China. Huawei provides support 10 hours a day, 7 days a week. Service requests are handled the subsequent business day. Optional service upgrades are available.
- Huawei provides a three-year warranty for parts replacement and repair for the servers used outside China. Huawei provides support 9 hours a day, 5 days a week. Service requests are handled the subsequent business day. Huawei delivers the repaired or new parts within 45 calendar days of receiving the defective parts.

Manageability and Security

The 2488H V5 provides the following features to enhance manageability and security:

- The built-in iBMC module monitors server operating status and provides remote management.
- The 2488H V5 supports a BIOS password to ensure system startup and management security.
- The Network Controller Sideband Interface (NC-SI) feature allows a network port to provide functions of both a management network port and a service port. This feature is disabled by default and can be enabled on the iBMC or BIOS.
- The integrated industry-standard Unified Extensible Firmware Interface (UEFI) increases configuration and update efficiency, and simplifies fault handling.

- The trusted platform module (TPM) provides advanced encryption functions, such as digital signatures and remote authentication.
- The front bezel in the server chassis is locked to ensure local data security and reliability.
- The Intel Execute Disable Bit (EDB) function prevents malicious buffer overflow attacks when working with a supported OS.
- The Intel® Trusted Execution technology provides enhanced security by using hardware-based defense against malicious software attacks, allowing an application to run in an isolated space from all other applications running on the OS.

 **NOTE**

The service network port supporting NC-SI has the following features:

- The service network port can be bound to any network port (host network port 1 by default) on the LAN on motherboard (LOM) of the server.
- The service network port allows you to enable, disable, and configure a virtual local area network (VLAN) ID. The VLAN ID is disabled by default, and the default VLAN ID is 0.
- The service network port supports IPv4 and IPv6 addresses. You can set an IP address, subnet mask, default gateway, and IPv6 address prefix length for the service network port.

Energy Efficiency

The 2488H V5 offers the following features to save energy:

- The 1288H V5 supports 80 Plus Platinum power supply units (PSUs). The PSUs provide 94% power efficiency at 50% loads.
- The voltage regulator-down (VRD) PSUs reduce the energy loss in DC/DC power conversion.
- The 2488H V5 supports area-based and intelligent fan speed adjustment, Proportional-Integral-Derivative (PID) speed adjustment, and intelligent processor frequency adjustment, reducing power consumption.
- The improved thermal design with energy-efficient fans ensures optimal heat dissipation and reduces system power consumption.
- The 2488H V5 supports power capping and power control.
- Drives are not powered on simultaneously, which reduces the server startup power consumption.
- The Intel® Intelligent Power Capability allows a single processor to be powered on or off based on site requirements.
- Low-voltage Intel® Xeon® processors consume less energy and apply to the data center and telecommunication environments that have power and thermal limitations.
- SSDs consume 80% less power than HDDs.

Support for Customization

- Huawei designs the product and owns the intellectual property.
- Huawei provides quick customized development and delivery.

3 Logical Structure

Figure 3-1 shows the logical structure of the 2488H V5.

The 2488H V5 supports up to four Intel® Xeon® Scalable CPUs and also supports the configuration of only two CPUs. Each CPU supports six memory channels and each channel supports two DIMMs per channel (2DPC). Therefore, each CPU supports a maximum of 12 DIMM slots. When equipped with four CPUs, the 2488H V5 supports a maximum of 48 DDR4 DIMMs. The CPUs interconnect with each other in a full-mesh topology through Ultra Path Interconnect (UPI) links at a speed of up to 10.4 GT/s.

The 2488H V5 provides 11 standard PCIe 3.0 slots of various specifications, and provides low-speed I/O ports, such as the VGA port, USB 3.0 ports, and serial port (RJ45) to meet the requirements in various application scenarios.

The 2488H V5 provides two 10GE optical LOM ports and two GE electrical LOM ports to meet basic I/O requirements of users without connecting external PCIe cards.

Figure 3-1 Logical structure of the 2488H V5

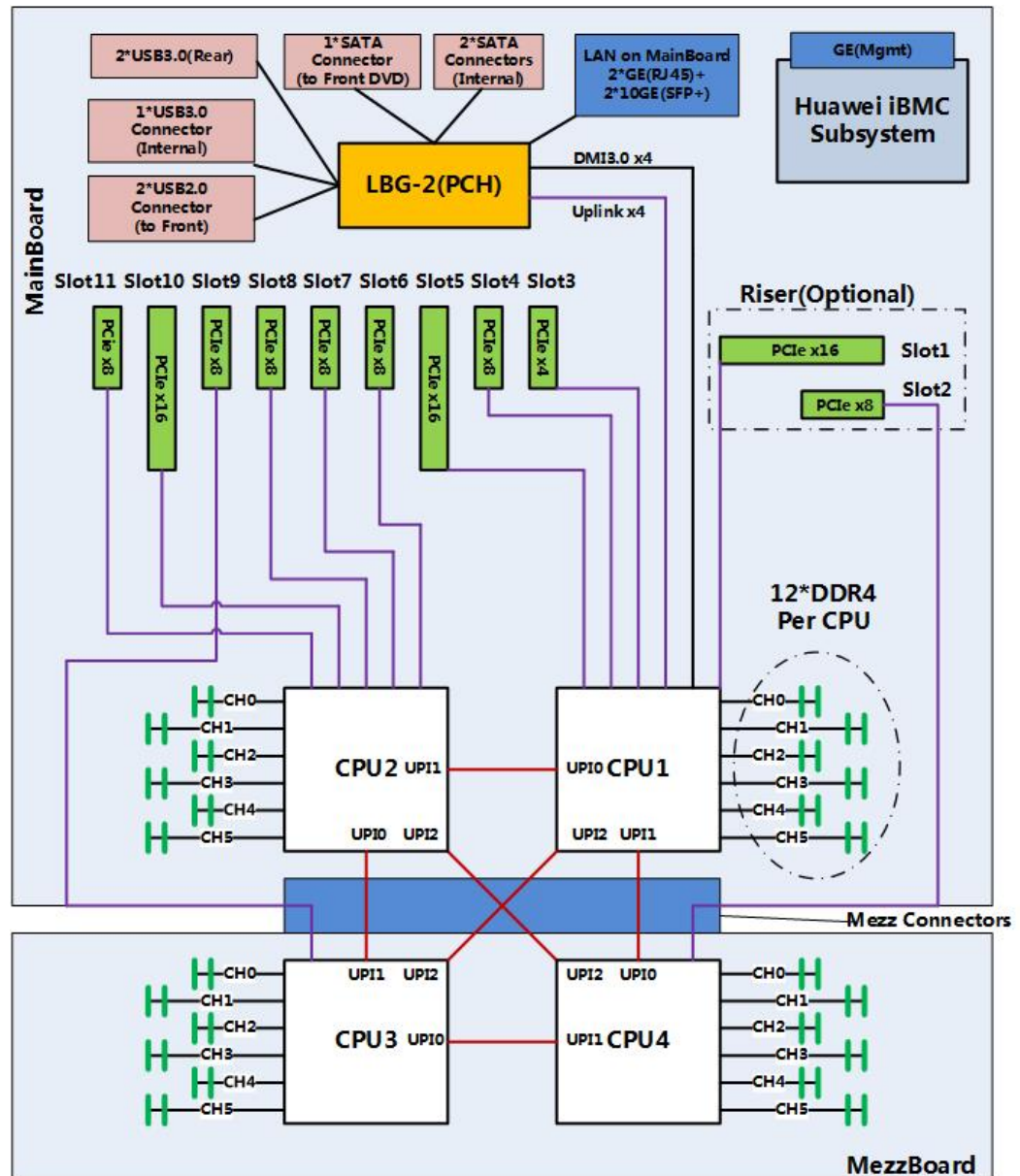

4 Hardware Description

- 4.1 Appearance
- 4.2 Ports
- 4.3 Indicators and Buttons
- 4.4 PCIe Slots
- 4.5 Physical Structure

4.1 Appearance

Front Panel

- **Figure 4-1** shows the front panel of the 2488H V5 with eight drives.

Figure 4-1 Front panel of the 2488H V5 with eight drives

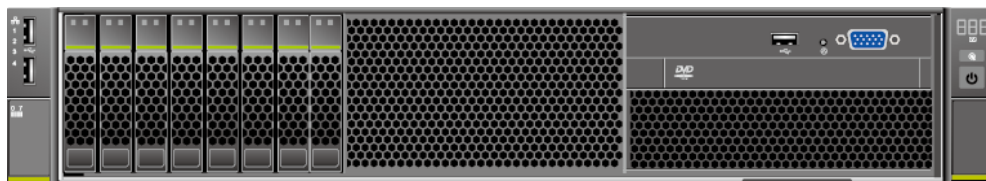

- **Figure 4-2** shows the front panel of the 2488H V5 with 25 drives.

Figure 4-2 Front panel of the 2488H V5 with 25 drives



- **Figure 4-3** shows the front panel of the 2488H V5 with 24 drives.

NOTE

The 24-drive configuration supports 24 SAS/SATA drives ,16 SAS/SATA drives+ 8 NVMe SSDs or 24 NVMe SSDs .

Figure 4-3 Front panel of the 2488H V5 with 24 drives



Rear Panel

Figure 4-4 shows the 2488H V5 rear panel.

Figure 4-4 Rear panel

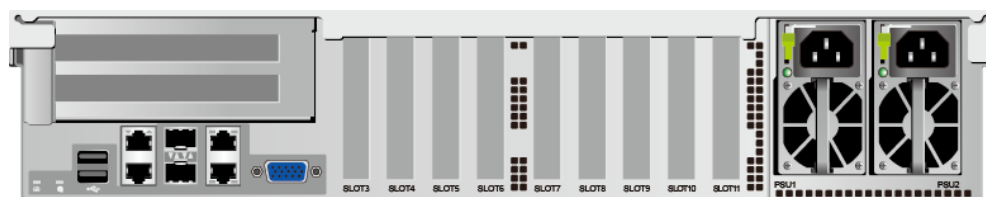

4.2 Ports

Front Panel

- **Figure 4-5** shows the front panel of the 2488H V5 with 8 SAS/SATA drives.

Figure 4-5 Front panel of a server with 8 SAS/SATA drives



1	USB 3.0 ports	2	VGA port
3	Label (with the SN label)	4	Built-in DVD drive or touchable LCD module
5	SAS/SATA drives	6	USB 2.0 ports

- **Figure 4-6** shows the front panel of the 2488H V5 with 24 SAS/SATA drives.

Figure 4-6 Front panel of a server with 24 SAS/SATA drives

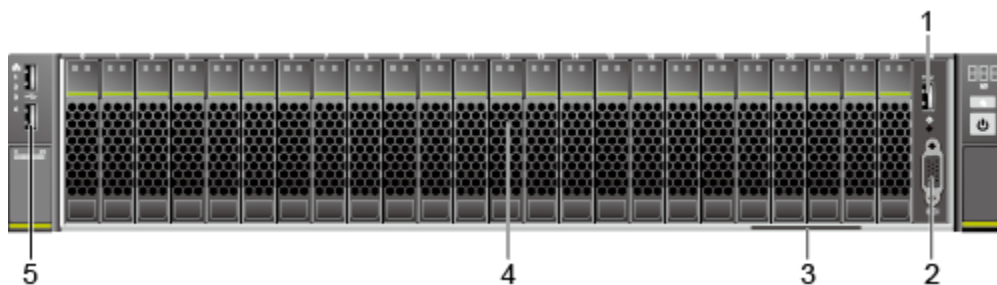

1	USB 3.0 ports	2	VGA port
3	Label (with the SN label)	4	SAS/SATA drives
5	USB 2.0 ports	-	-

- **Figure 4-7** shows the front panel of the 2488H V5 with 25 SAS/SATA drives.

Figure 4-7 Front panel of a server with 25 SAS/SATA drives

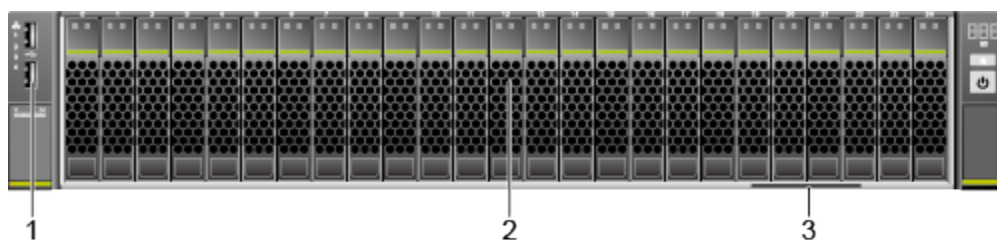

1	USB 2.0 ports	2	SAS/SATA drives
3	Label (with the SN label)	-	-

- **Figure 4-8** shows the front panel of the 2488H V5 with 16 SAS/SATA drives and 8 NVMe SSDs.

Figure 4-8 Front panel of a server with 16 SAS/SATA drives and 8 NVMe SSDs

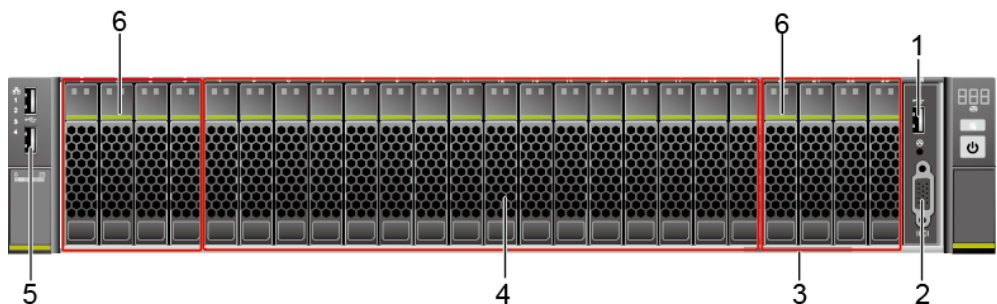

1	USB 3.0 ports	2	VGA port
---	---------------	---	----------

3	Label (with the SN label)	4	SAS/SATA drives
5	USB 2.0 ports	6	NVMe SSDs
Note: The four leftmost slots and the four rightmost slots support a total of eight NVMe SSDs.			

- **Figure 4-9** shows the front panel of the 2488H V5 with 24 NVMe SSDs.

Figure 4-9 Front panel of a server with 24 NVMe SSDs

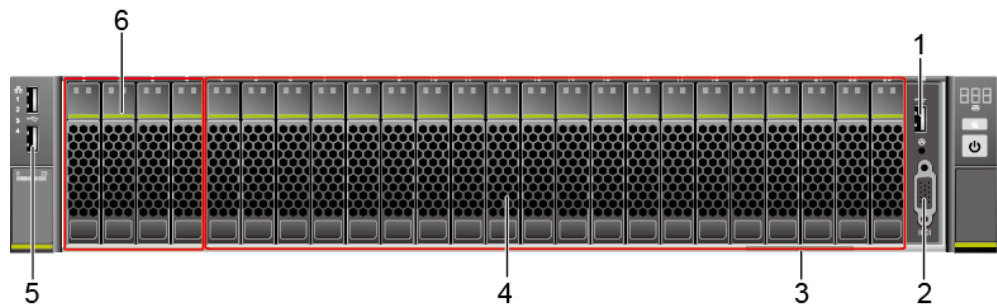

1	USB 3.0 ports	2	VGA port
3	Label (with the SN label)	4	NVMe SSDs
5	USB 2.0 ports	6	SAS/SATA drives or NVMe SSDs

Table 4-1 Ports on the front panel

Port	Type	Description
VGA port	DB15	The VGA port is connected to a terminal, such as a monitor or physical KVM.
USB port	USB 2.0/USB 3.0	The USB ports allow USB devices to be connected to the server. NOTE Before connecting an external USB device, check that the USB device functions properly. A server may operate abnormally if an abnormal USB device is connected.

Rear Panel

Figure 4-10 shows the 2488H V5 rear panel.

Figure 4-10 Rear panel

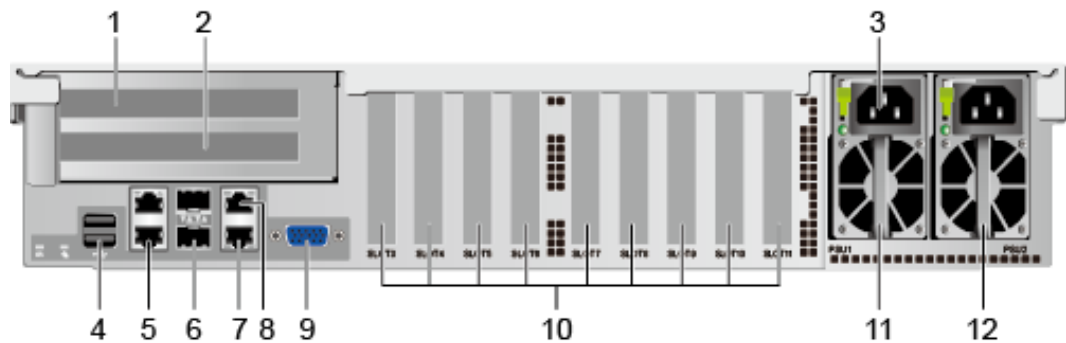

1	PCIe slot 1	2	PCIe slot 2
3	PSU socket	4	USB 3.0 port
5	GE electrical port	6	10GE optical port
7	Management network port	8	Serial port
9	VGA port	10	PCIe slots (3 to 11 from left to right)
11	PSU 1	12	PSU 2

Table 4-2 Ports on the rear panel

Port	Type	Quantity	Description
GE electrical port	Electrical port	2	The mainboard provides two GE electrical LOM ports and two 10GE optical LOM ports, supports the X722 NIC, but does not support other electrical and optical LOM ports. NOTE <ul style="list-style-type: none"> The LOM ports do not support the forcible rate and or SR-IOV feature. 10GE optical ports do not support 10 Mbit/s or 100 Mbit/s networks and the rate cannot be forcibly set to 1000 Mbit/s. GE electrical port does not support forcible rates or 10 Mbit/s and 100 Mbit/s networks. The X722 NIC with GE electrical ports does not support interconnection with the PoE power supply device, for example, the PoE switch with the PoE function enabled. If the NIC is forcibly connected, the link communication may be abnormal or the NIC may be damaged.
10GE optical port	Optical port	2	
VGA port	DB15	1	The VGA port is connected to a terminal, such as a monitor or physical KVM.

Port	Type	Quantity	Description
Serial port	RJ45	1	The serial port is used as the system serial port by default. You can set it as the iBMC serial port by using the iBMC command. This port is used for debugging.
Management network port	Ethernet port	1	The 1000 Mbit/s Ethernet port is used for server management, support 10/100/1000 Mit/s auto-negotiation.
USB port	USB 3.0	2	The USB ports allow USB devices to be connected to the server. NOTE Before connecting an external USB device, check that the USB device functions properly. A server may operate abnormally if an abnormal USB device is connected.
PSU socket	-	1 or 2	Determine the number of PSUs based on actual requirements, but ensure that the rated power of the PSUs is greater than that of the server. When one PSU is used, Predicted PSU Status on the iBMC WebUI cannot be set to Active/Standby .

4.3 Indicators and Buttons

Front Panel Indicators and Buttons

- **Figure 4-11** shows the indicators and buttons on the front panel of a server with eight 2.5-inch drives.

Figure 4-11 Front panel of a server with eight 2.5-inch drives



1	Network port connection status indicators (1 to 4 from top to bottom)	2	Non-Maskable Interrupt (NMI) button
3	Fault diagnostic LED	4	Health indicator
5	Unit Identification (UID) button/indicator	6	Power button/indicator

- **Figure 4-12** shows the indicators and buttons on the front panel of a server with twenty-four 2.5-inch drives.

NOTE

The 24-drive configuration supports 24 SAS/SATA drives, 16 SAS/SATA drives+ 8 NVMe SSDs or 24 NVMe SSDs.

Figure 4-12 Front panel of a server with twenty-four 2.5-inch drives

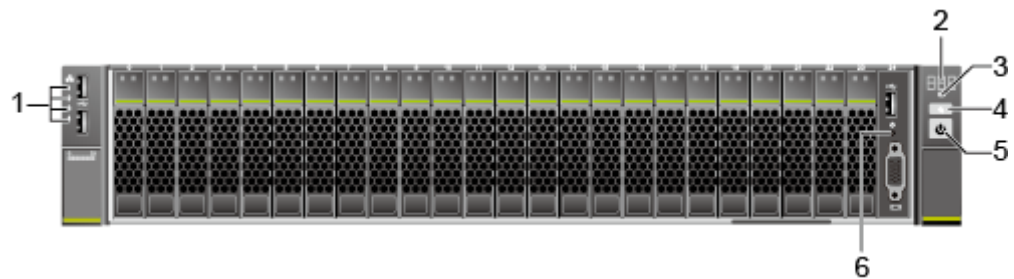

1	Network port connection status indicators (1 to 4 from top to bottom)	2	Fault diagnostic LED
3	Health indicator	4	UID button/indicator
5	Power button/indicator	6	NMI button

- **Figure 4-13** shows the indicators and buttons on the front panel of a server with twenty-five 2.5-inch drives.





Figure 4-13 Front panel of a server with twenty-five 2.5-inch drives



1	Network port connection status indicators (1 to 4 from top to bottom)	2	Fault diagnostic LED
3	Health indicator	4	UID button/indicator
5	Power button/indicator	-	-

Table 4-3 describes the indicators and buttons on the front panel.

Table 4-3 Indicators and buttons on the front panel

Silk Screen	Indicator/ Button	State Description
	Fault diagnostic LED	<ul style="list-style-type: none"> • ---: The server is operating normally. • Error code: A server component is faulty. For details about error codes, see the Huawei Rack Server iBMC Alarm Handling.
	Power button/ indicator	<p>Power indicator</p> <ul style="list-style-type: none"> • Steady yellow: The server is ready to power on. • Steady green: The server is properly powered on. • Blinking yellow: The iBMC is starting. • Off: The server is not connected to a power source. <p>Power button</p> <ul style="list-style-type: none"> • When the server is powered on, you can press this button to shut down the OS. • When the server is powered on, you can hold down this button for 6 seconds to force the server to power off. <p>NOTE After the server is powered off forcibly, wait for more than 10s to ensure that the server is powered off completely. Then you can power on the server again.</p> <ul style="list-style-type: none"> • When the server is ready to power on, you can press this button to start the server.
	UID button/ indicator	<p>UID indicator</p> <ul style="list-style-type: none"> • Steady blue/Blinking blue: The server is being located. • Off: The server is not being located. <p>UID button</p> <ul style="list-style-type: none"> • You can press this button to turn on or off the UID indicator. • You can press and hold down this button for 4 to 6 seconds to reset the iBMC.
	Health indicator	<ul style="list-style-type: none"> • Steady green: The server is operating properly. • Blinking red at 1 Hz: A major alarm has been generated on the server. • Blinking red at 5 Hz: A critical alarm has been generated on the server.

Silk Screen	Indicator/ Button	State Description
○	NMI button	The NMI button triggers a server to generate a non-maskable interrupt. You can press this button or control it remotely through the iBMC WebUI. NOTE <ul style="list-style-type: none"> ● Use the NMI button only when the OS is abnormal. Do not use this button when the server is operating properly. ● Use the NMI button only for internal commissioning. Before using this button, ensure that the OS has the NMI processing program. Otherwise, the OS may crash. Exercise caution when using this button.
	Network port connection status indicator	Each indicator shows the status of an Ethernet port on the LOM. <ul style="list-style-type: none"> ● Steady green: The network port is properly connected. ● Off: The network port is not in use or has failed. NOTE The indicators correspond to the two 10GE and two GE LOM ports.

Rear Panel Indicators

Figure 4-14 shows the indicators on the rear panel of a server.

Figure 4-14 Indicators on the rear panel

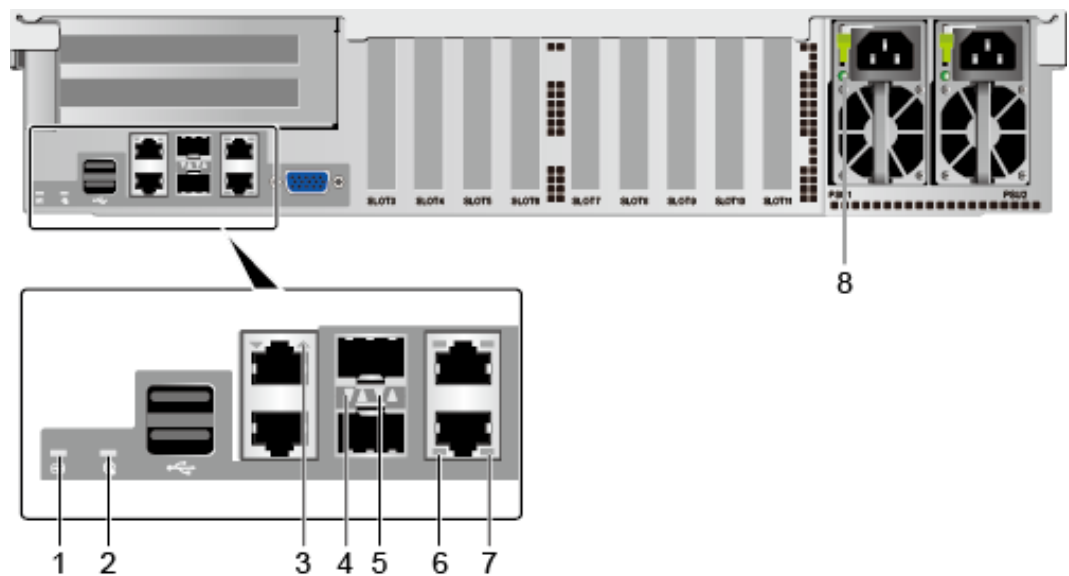

1	Health indicator	2	UID indicator
3	Connection status indicator/Data transmission status indicator	4	Connection status indicator/Data transmission status indicator
5	Transmission rate indicator	6	Data transmission status indicator

7	Connection status indicator	8	PSU indicator
---	-----------------------------	---	---------------

Table 4-4 Indicators on the rear panel

Indicator		State Description
Two GE electrical ports	Connection status indicator/Data transmission status indicator	<ul style="list-style-type: none"> ● Steady green and yellow: The network port is properly connected. ● Blinking green and yellow alternately: Data is being transmitted. ● Off: The network port is not connected.
Two 10GE optical ports	Connection status indicator/Data transmission status indicator	<ul style="list-style-type: none"> ● Steady green: The network port is properly connected. ● Blinking green: Data is being transmitted. ● Off: The network port is not connected.
	Transmission rate indicator	<ul style="list-style-type: none"> ● Steady green: The data transmission rate is 10 Gbit/s. ● Steady yellow: The data transmission rate is lower than 10 Gbit/s. ● Off: The network port is not connected.
Management network port	Connection status indicator	<ul style="list-style-type: none"> ● Steady green: The network port is properly connected. ● Off: The network port is not connected.
	Data transmission status indicator	<ul style="list-style-type: none"> ● Blinking yellow: Data is being transmitted. ● Off: No data is being transmitted.
UID indicator		<p>The UID indicator helps identify and locate a server. You can turn on or off the UID indicator by pressing the UID button, clicking the virtual button on the iBMC WebUI, or remotely running a command on the iBMC CLI.</p> <ul style="list-style-type: none"> ● Steady blue/Blinking blue: The server is being located. ● Off: The server is not being located.
Health indicator		<ul style="list-style-type: none"> ● Steady green: The server is operating properly. ● Blinking red at 1 Hz: A major alarm has been generated on the server. ● Blinking red at 5 Hz: A critical alarm has been generated on the server.

Indicator	State Description
PSU indicator	<ul style="list-style-type: none"> ● Steady green: The power input and output are normal. ● Steady orange: The input is normal, but no power output is supplied due to overheat protection, overcurrent protection, short circuit protection, output overvoltage protection, or some component failures. ● Blinking green at 1 Hz: <ul style="list-style-type: none"> - The input is normal, the server is standby, and the PSU is in MV6 mode. (The output voltage is 6.7 V.) - The input is overvoltage or undervoltage. - The PSU is in deep hibernation mode. ● Blinking green at 4 Hz: under online firmware upgrade. ● Off: No AC power is supplied.

SAS/SATA Drive Indicators

Figure 4-15 shows the SAS/SATA drive indicators.

Figure 4-15 SAS/SATA drive indicators

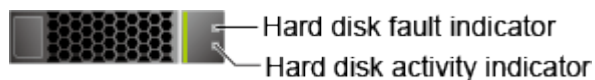

describes the SAS/SATA drive indicators.

Table 4-5 SAS/SATA drive indicators

Indicator	State Description
Drive fault indicator	<ul style="list-style-type: none"> ● Off: The drive is operating normally or not detected in a RAID array. ● Blinking yellow: The server is locating the drive or rebuilding RAID. ● Steady yellow: The drive is not detected, the drive is faulty, or the RAID array status of the drive is abnormal. <p>NOTE If the fault indicator is steady yellow, run a command to check the RAID status to determine whether the RAID array status is abnormal or whether the drive is faulty. For details about command description, see Huawei V5 Server RAID Controller Card User Guide.</p>

Indicator	State Description
Drive activity indicator	<ul style="list-style-type: none"> ● Off: The drive is faulty or not detected. ● Blinking green: Data is being read from or written to the drive, or synchronized between drives. ● Steady green: The drive is inactive.

NVMe SSD Indicators

Figure 4-16 shows the NVMe SSD indicators.

Figure 4-16 NVMe SSD indicators



Table 4-6 describes the NVMe SSD indicators.

Table 4-6 Indicators on NVMe SSDs

Green Indicator	Yellow Indicator	State Description
Off	Off	The NVMe SSD cannot be detected.
Steady green	Off	The NVMe SSD is detected and working properly.
Blinking green at 2 Hz	Off	Data is being read from or written to the NVMe SSD.
Off	Blinking yellow at 2 Hz	The NVMe SSD is being hot-swapped.
Off	Blinking yellow at 0.5 Hz	The NVMe SSD completes the hot removal process and is removable.
Steady green or off	Steady yellow	The NVMe SSD is faulty.

4.4 PCIe Slots

Figure 4-17 shows the PCIe slot layout of the 2488H V5.

Figure 4-17 PCIe slots

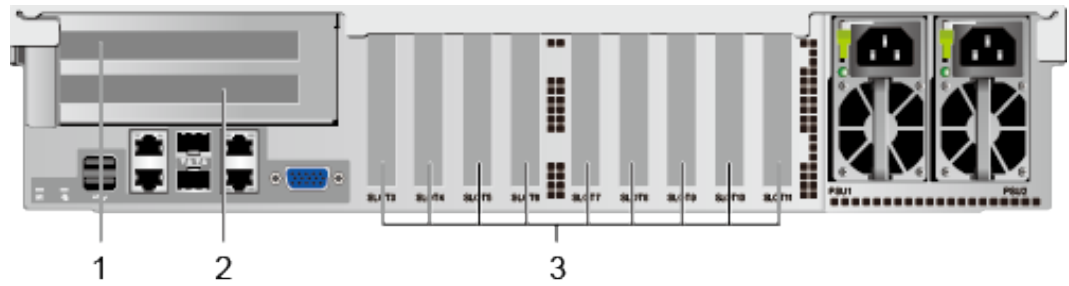

1	PCIe slot 1	2	PCIe slot 2
3	PCIe slot (3 to 11 from left to right)	-	-

The riser card provides slot 1 and slot 2, and the mainboard provides slots 3 to 11.

Table 4-7 describes the mapping between PCIe slots and CPUs, and the PCIe specifications of the 2488H V5.

NOTE

The PCIe slots mapping to a vacant CPU socket are unavailable.

Table 4-7 PCIe slot description

PCIe Device	CPU	PCIe Standard	Connector Bandwidth	Bus Width	Port Number	Bus/Device/Function Number (B/D/F)	Slot Size
Slot 1	CPU 1	PCIe 3.0	x16	x16	Port 3a	0x32/0x00/0x00	full-height 3/4-length
Slot 2	CPU 4	PCIe 3.0	x8	x8	Port 2a	0xE2/0x00/0x00	full-height half-length
Slot 3	CPU 1	PCIe 3.0	x8	x4	Port 2c	0x24/0x02/0x00	Half-height half-length
Slot 4	CPU 1	PCIe 3.0	x8	x8	Port 2a	0x24/0x00/0x00	Half-height half-length

PCIe Device	CPU	PCIe Standard	Connect or Bandwidth	Bus Width	Port Number	Bus/ Device/ Function Number (B/D/F)	Slot Size
Slot 5	CPU 1	PCIe 3.0	x16	x16	Port 1a	0x08/0x00/0x00	Half-height half-length
Slot 6	CPU 2	PCIe 3.0	x8	x8	Port 2c	0x62/0x02/0x00	Half-height half-length
Slot 7	CPU 2	PCIe 3.0	x8	x8	Port 2a	0x62/0x00/0x00	Half-height half-length
Slot 8	CPU 2	PCIe 3.0	x8	x8	Port 1a	0x43/0x00/0x00	Half-height half-length
Slot 9	CPU 3	PCIe 3.0	x8	x8	Port 2a	0xA2/0x00/0x00	Half-height half-length
Slot 10	CPU 2	PCIe 3.0	x16	x16	Port 3a	0x71/0x00/0x00	Half-height half-length
Slot 11	CPU 2	PCIe 3.0	x8	x8	Port 1c	0x43/0x02/0x00	Half-height half-length
LOM	CPU1	PCIe3.0	-	x16	Port2d	0x24/0x03/0x00	-

PCIe Device	CPU	PCIe Standard	Connect or Bandwidth	Bus Width	Port Number	Bus/ Device/ Function Number (B/D/F)	Slot Size
<p>Note 1: The PCIe slots that support full-height 3/4-length PCIe cards are backwards compatible with full-height half-length or half-height half-length PCIe cards.</p> <p>Note 2: The PCIe slots that support PCIe x16 cards are backwards compatible with PCIe x8, PCIe x4, and PCIe x1 cards.</p> <p>Note 3: All slots support PCIe cards of up to 75 W. The power of a PCIe card depends on its model. Use the Huawei Server Compatibility Checker to check PCIe cards supported by the server. For PCIe cards not listed in the Huawei Server Compatibility Checker, contact your local Huawei sales personnel.</p> <p>Note 4: This table lists the default values of B/D/F when all CPU sockets and PCIe slots are populated. If the CPU sockets are not fully populated or a PCIe card with a PCI bridge is configured, the values of B/D/F may differ.</p>							

4.5 Physical Structure

8-Drive Configuration

The 8-drive configuration supports only eight SAS/SATA drives. The following table shows the components in the 8-drive configuration.

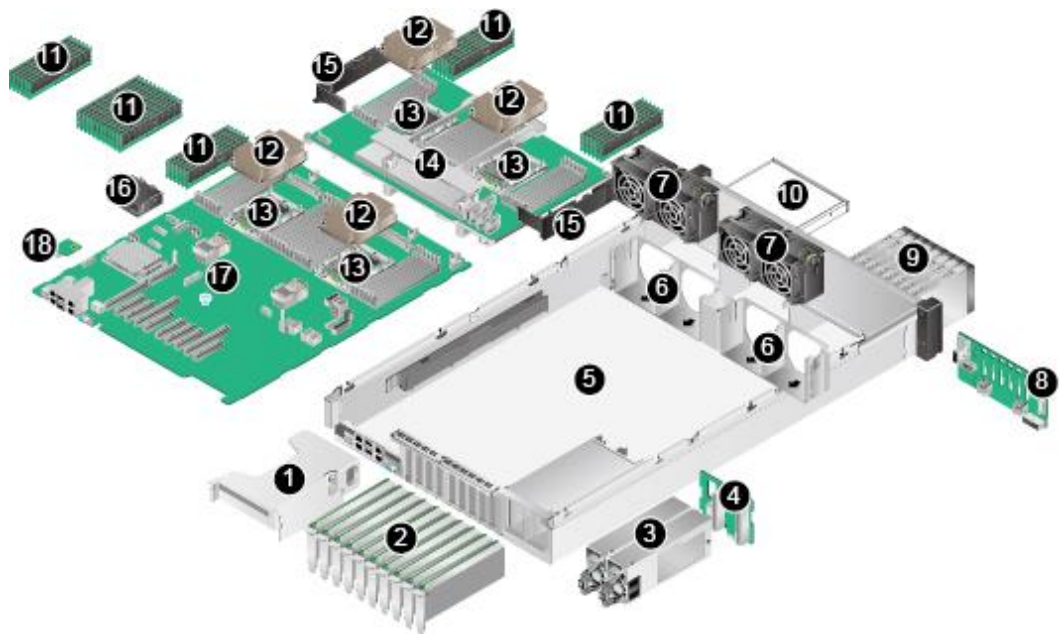

1	Riser card	2	PCIe cards
3	PSUs	4	PSU backplane

5	Chassis	6	Fan module brackets
7	Fan modules	8	Drive backplane
9	Drives	10	DVD-ROM drive (or LCD)
11	DIMMs	12	CPU heat sinks
13	CPUs	14	Daughter board handle
15	Daughter board supports	16	Supercapacitor
17	Mainboard	18	TPM

25-Drive Configuration

The 25-drive configuration supports only 25 SAS/SATA drives. The following table shows the components in the 25-drive configuration.

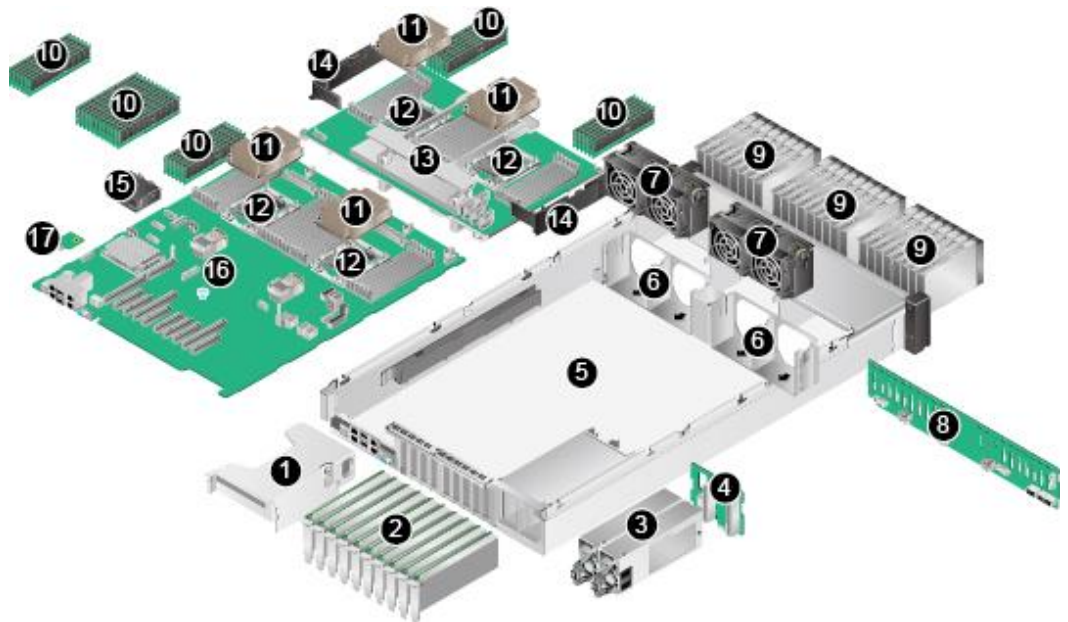

1	Riser card	2	PCIe cards
3	PSUs	4	PSU backplane
5	Chassis	6	Fan module brackets
7	Fan modules	8	Drive backplane
9	Drives	10	DIMMs
11	CPU heat sinks	12	CPUs
13	Daughter board handle	14	Daughter board handle
15	Supercapacitor	16	Mainboard

17	TPM	-	-
----	-----	---	---

24-Drive Configuration

The 24-drive configuration has three types:

- 8 NVMe SSDs + 16 SAS/SATA drives
- 24 SAS/SATA drives (pass-through)
- 24 NVMe SSDs

The following table shows the components in the 24-drive configuration.

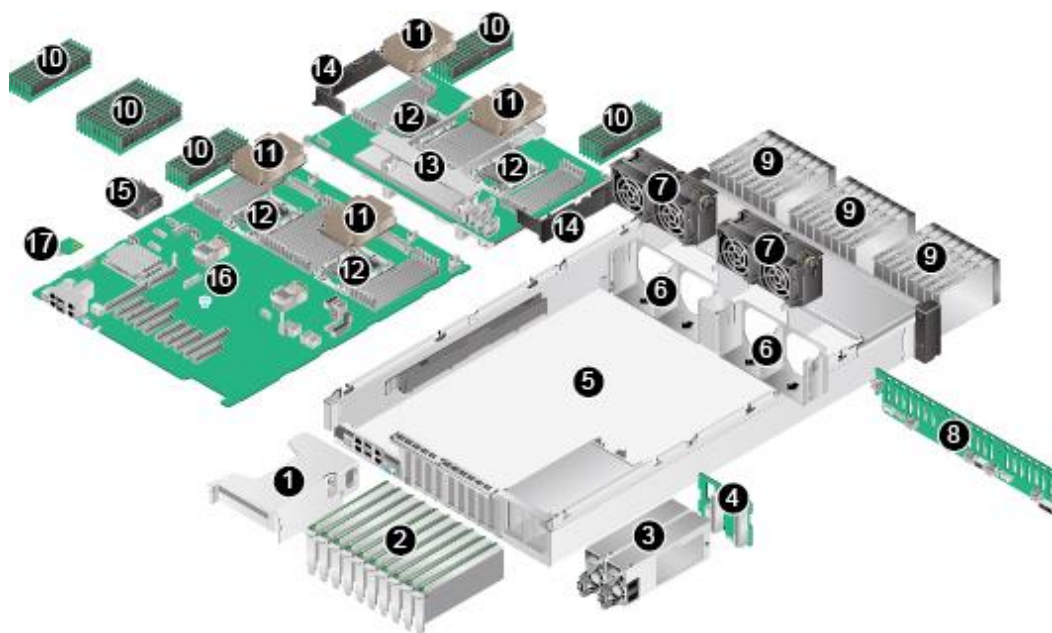

1	Riser card	2	PCIe cards
3	PSUs	4	PSU backplane
5	Chassis	6	Fan module brackets
7	Fan modules	8	Drive backplane
9	Drives	10	DIMMs
11	CPU heat sinks	12	CPUs
13	Daughter board handle	14	Daughter board handle
15	Supercapacitor	16	Mainboard
17	TPM	-	-

5 Product Specifications

[5.1 Technical Specifications](#)

[5.2 Physical Specifications](#)

5.1 Technical Specifications

Table 5-1 lists the 2488H V5 technical specifications.

Table 5-1 Technical specifications

Item	Specifications
Form factor	2U rack server
CPU	Up to four Intel® Xeon® Scalable processors (Skylake, Cascade Lake), supporting a maximum of three 10.4 GT/s UPI links, 2933MT/s DIMMs of up to 6TB, and 48 PCIe 3.0 links NOTE The server supports two or four CPUs. If two CPUs are configured, install them to slots 1 and 2.
Chipset	Intel C622

Item	Specifications
Memory	<ul style="list-style-type: none">● Up to 48 DDR4 DIMM slots (eight DDR4 DIMM slots per CPU) for installing 12 RDIMMs or LRDIMMs.● Maximum memory speed: 2933 MT/s● 48 x 32 GB RDIMMs, with a maximum memory capacity of 1.5 TB● 48 x 64 GB LRDIMMs, with a maximum memory capacity of 3 TB● 48 x 128 GB LRDIMMs, with a maximum memory capacity of 6 TB● Data protection measures: ECC, memory mirroring, single device data correction (SDDC), adaptive double device data correction (ADDDC), and lockstep <p>NOTE DIMMs of different types (RDIMMs and LRDIMMs) and specifications (such as the capacity, bit width, rank, and height) cannot be installed on one server. The DIMMs on one server must have the same BOM number. For details about BOM numbers, use the Huawei Server Compatibility Checker.</p>

Item	Specifications
Storage	<ul style="list-style-type: none"> ● The 2488H V5 supports the following drive configurations: <ul style="list-style-type: none"> - 8 SAS/SATA drives: eight 2.5-inch front SAS/SATA drives with one PCIe RAID controller card - 25 SAS/SATA drives: twenty-five 2.5-inch front SAS/SATA drives with one PCIe RAID controller card - 24 SAS/SATA pass-through drives: twenty-four 2.5-inch front SAS/SATA drives with three PCIe RAID controller cards - 24 NVMe SSDs: twenty-four 2.5-inch front NVMe SSDs with two NVMe adapters (Slots 0 to 3 can be configured with 2.5-inch SAS/SATA drives. In this case, two NVMe adapters and one plug-in PCIe RAID controller card need to be configured.) - 16 SAS/SATA drives + 8 NVMe SSDs: sixteen 2.5-inch front SAS/SATA drives and eight 2.5-inch front NVMe SSDs with one SAS RAID controller card and two NVMe adapters ● Supports drive hot swap. ● Supports RAID 0, 1, 10, 1E, 5, 50, 6, and 60, provides an iBBU or supercapacitor to protect cache data from power failures, and supports RAID level migration, drive roaming, self-diagnosis, and web-based configuration. ● Allows a SAS RAID controller card (with 2 or 4 GB cache) to be configured on the mainboard to improve drive storage performance and supports a supercapacitor for power failure protection to ensure user data security. <p>NOTE The maximum storage capacity of the server varies depending on the maximum capacity of a single drive. For details about the maximum storage capacity of the server, contact your local Huawei sales representatives.</p>
Network port	<p>Two LOM GE network ports (RJ45) and two LOM 10GE network ports (SFP+) are supported. The NIC chip is X722. All the ports support the NC-SI and PXE functions.</p> <p>NOTICE The X722 NIC with GE electrical ports does not support interconnection with the PoE power supply device, for example, the PoE switch with the PoE function enabled. If the NIC is forcibly connected, the link communication may be abnormal or the NIC may be damaged.</p>

Item	Specifications
RAID controller card	<p>The RAID controller card supports RAID level migration and drive roaming. The server supports the following RAID controller cards:</p> <ul style="list-style-type: none"> ● Broadcom SAS3508 (SR450C-M): supports RAID 0, 1, 5, 6, 10, 50, and 60, 2 or 4 GB cache, a supercapacitor for power-off protection, and out-of-band iBMC management. ● Broadcom SAS3408 (SR150-M): supports RAID 0, 1, and 10, and out-of-band iBMC management, but does not support power-off protection. ● Broadcom 9361-8i: supports RAID 0, 1, 5, 6, 10, 50, and 60, 1 GB cache, a supercapacitor for power-off protection, and out-of-band iBMC management. <p>NOTE These standards PCIe RAID controller cards need to be installed in specified slots.</p>
PCIe slot	<ul style="list-style-type: none"> ● Supports a maximum of 11 PCIe 3.0 slots, among which slots 1 and 2 are riser card slots and slots 3 to 11 are LOM slots. See PCIe Slots. <ul style="list-style-type: none"> - Slots 5 and 10 are x16 ports that support half-height half-length standard PCIe cards and slot 1 is a x16 port that supports a full-height 3/4-length standard PCIe card. - Slots 2, 4, 6, 7, 8, 9, and 11 are x8 ports, where slot 2 supports a full-height half-length PCIe card and the other ports support half-height half-length standard PCIe cards. - Slot 3 is a x4 port using a x8 slot and supports a half-height half-length standard PCIe card. ● Supports Huawei-developed NVMe SSD cards, which greatly improves I/O performance for search, cache, and download services. <p>NOTE</p> <ul style="list-style-type: none"> ● Use the Huawei Server Compatibility Checker to check the PCIe cards supported by the server. For PCIe cards not listed in the Huawei Server Compatibility Checker, contact your local Huawei sales representative or Huawei technical support. ● For details about the PCIe slot configuration, contact your local Huawei sales representative.
Port	<ul style="list-style-type: none"> ● Two USB 2.0 ports, one USB 3.0 port, and one DB15 VGA port on the front panel (2488H V5 with eight 2.5-inch or twenty-four 2.5-inch drives) ● Two USB 2.0 ports on the front panel (2488H V5 with twenty-five 2.5-inch drives) ● Two USB 3.0 ports, one DB15 VGA port, one RJ45 serial port, and one RJ45 management network port on the rear panel

Item	Specifications
Fan module	Four hot-swappable 8038+ fan modules, allowing one-fan failures
PSU	<p>The power ratings of PSUs are as follows:</p> <ul style="list-style-type: none"> ● 1500 W AC PSU <ul style="list-style-type: none"> - 1000 W (input voltage range: 100 V AC to 127 V AC) - 1500 W (input voltage range: 200 V AC to 240 V AC) - 1500 W (input voltage range: 190 V DC to 300 V DC) ● 900 W AC PSU <ul style="list-style-type: none"> - 900 W (input voltage range: 100 V AC to 240 V AC) - 900 W (input voltage range: 190 V DC to 290 V DC) ● 1200 W AC PSU <ul style="list-style-type: none"> - 1200 W (input voltage: 38.4 V DC to 72 V DC) <p>NOTE</p> <ul style="list-style-type: none"> ● When the input voltage of 1500 W AC PSUs is 100 V AC to 127 V AC, if the output power is greater than 1000 W, the PSUs do not support 1+1 redundancy; if the output power is less than 1000 W, the PSUs support 1+1 redundancy. ● For more information about PSUs, use the Huawei Server Compatibility Checker.
System management	<ul style="list-style-type: none"> ● UEFI ● Huawei iBMC <p>Uses an independent port.</p> <p>Supports Simple Network Management Protocol (SNMP) and Intelligent Platform Management Interface (IPMI).</p> <p>Provides the GUI, virtual KVM, virtual media, Serial Over LAN (SOL), intelligent power supply, remote control, and hardware monitoring features.</p> ● NC-SI ● Huawei eSight management software and third-party management systems, such as VMware vCenter, Microsoft SystemCenter, and Nagios
Security	<ul style="list-style-type: none"> ● Power-on password ● Administrator password ● TPM ● Secure boot ● Front bezel

Item	Specifications
Video card	<p>Integrates an SM750 graphics card chip to the mainboard to provide a memory capacity of 32 MB and support a maximum resolution of 1920 x 1200 at 60 Hz with 16 M colors.</p> <p>NOTE</p> <ul style="list-style-type: none"> ● The maximum resolution 1920 x 1200 is supported only when a compatible graphics card driver is installed. Otherwise, only the default resolution supported by the OS is available. ● On a server that provides front and rear VGA ports, if only one VGA port is connected to a monitor, the display effect may be affected.
Operating system	<ul style="list-style-type: none"> ● SUSE Linux Enterprise Server 12 SP2 ● Red Hat Enterprise Linux 7.3 ● Windows Server 2012 R2 ● Windows Server 2016 ● Citrix 6.2 ● CentOS 6.9 ● CentOS 7.3 ● Ubuntu 14.04.5 ● Ubuntu 16.04.2 <p>NOTE The preceding information is for reference only. To check the supported OS versions, use the Huawei Server Compatibility Checker.</p>
Dimensions (H x W x D)	86.1 mm (2U) x 447 mm x 748 mm (3.39 in. x 17.60 in. x 29.45 in.)
Weight	<p>Net weight:</p> <ul style="list-style-type: none"> ● With eight 2.5-inch drives: 28 kg (61.74 lb) ● With twenty-four 2.5-inch drives: 30 kg (66.15 lb) ● With twenty-five 2.5-inch drives: 31 kg (68.36 lb) <p>Packaging materials: 5 kg (11.03 lb)</p>

5.2 Physical Specifications

[Table 5-2](#) lists the 2488H V5 physical specifications.

Table 5-2 Physical specifications

Item	Specifications
Dimensions (H x W x D)	86.1 mm (2U) x 447 mm x 748 mm (3.39 in. x 17.60 in. x 29.45 in.)

Item	Specifications
Installation space	The server fits into a universal cabinet that complies with the IEC 297 standard. <ul style="list-style-type: none"> ● Cabinet width: 19 in. ● Cabinet depth: 900 mm (35.43 in.) or larger
Weight in full configuration	<ul style="list-style-type: none"> ● With eight 2.5-inch drives: 28 kg (61.74 lb) ● With twenty-four 2.5-inch drives: 30 kg (66.15 lb) ● With twenty-five 2.5-inch drives: 31 kg (68.36 lb) Packaging materials: 5 kg (11.03 lb)
Temperature	Operating temperature: 5°C to 45°C (41°F to 113°F) (ASHRAE CLASS A2 to A4 compliant) Storage temperature: -40°C to +65°C (-40°F to +149°F) Temperature change rate: < 20°C/h (36°F/h) Long-term storage temperature: 21°C to 27°C (69.8°F to 80.6°F) NOTE For details, see Table 5-3 .
Humidity	Operating humidity: 8% RH to 90% RH (non-condensing) Storage humidity: 5% to 95% RH (non-condensing) Humidity change rate: < 20% RH/h
Air volume	≥ 196 CFM
Altitude	≤3050m(10006.44ft),according to the ASHRAE standards of 2015, for altitudes above 950 m (3116.79 ft), the highest operating temperature decreases by 1°C (1.8°F) for every increase of: <ul style="list-style-type: none"> ● 300 m (984.24 ft) in altitude when the server configuration complies with Class A2 standards. ● 175 m (575.14 ft) in altitude when the server configuration complies with Class A3 standards. ● 125 m (410.10 ft) in altitude when the server configuration complies with Class A4 standards.

Item	Specifications
Acoustic noise	<p>The data listed in the following is the declared A-weighted sound power levels (LWAd) and declared average bystander position A-weighted sound pressure levels (LpAm) when the server is operating in a 23°C (73.4°F) ambient environment. Noise emissions are measured in accordance with ISO 7999 (ECMA 74) and declared in accordance with ISO 9296 (ECMA 109).</p> <ul style="list-style-type: none"> ● Idle: <ul style="list-style-type: none"> - LWAd: 5.3 Bels - LpAm: 38.1 dBA ● Operating: <ul style="list-style-type: none"> - LWAd: 6.3 Bels - LpAm: 48.2 dBA <p>NOTE The actual sound levels generated when the server is operating vary depending on the server configuration, workload, and ambient temperature.</p>

Table 5-3 lists the 2488H V5 temperature specifications.

Table 5-3 Temperature specifications

Model	Maximum Operating Temperature			
	30°C	35°C (95°F) (ASHRAE CLASS A2 compliant)	40°C (104°F) (ASHRAE CLASS A3 compliant)	45°C (113°F) (ASHRAE CLASS A4 compliant)
Server with eight 2.5-inch drives	All configurations are supported under this temperature.	All configurations are supported under this temperature.	<ul style="list-style-type: none"> ● CPUs with a maximum thermal design power (TDP) of 165 W are supported. ● GPUs are not supported. 	<ul style="list-style-type: none"> ● CPUs with a maximum TDP of 140 W are supported. ● PCIe SSDs are supported. ● GPUs are not supported.

Server with twenty-four 2.5-inch drives Server with twenty-five 2.5-inch drives			<ul style="list-style-type: none"> ● CPUs with a maximum TDP of 165 W are supported. ● PCIe SSDs are supported. ● GPUs are not supported. 	Not supported
Server with eight drives and sixteen 2.5-inch NVMe SSDs			<ul style="list-style-type: none"> ● CPUs with a maximum TDP of 140 W are supported. ● PCIe SSDs are supported. ● GPUs are not supported. 	Not supported
Server with twenty-four 2.5-inch NVMe SSDs	CPUs with a maximum TDP of 165 W are supported.	Not supported	Not supported	Not supported
<p>NOTE</p> <ul style="list-style-type: none"> ● If one fan fails, the highest operating temperature of the server is 5°C (9°F) lower than that in normal cases. ● A server with 24 NVMe SSDs does not support the P4 GPU cards. When the P4 GPUs are configured on other servers, 35°C (95°F) is supported only in slot 1. 				

6 Component Compatibility

Use the [Huawei Server Compatibility Checker](#) to check the software and hardware supported by the server.

[6.1 CPU](#)

[6.2 Memory](#)

[6.3 Storage](#)

[6.4 I/O Expansion](#)

[6.5 PSU](#)

[6.6 OS and Software Support](#)

6.1 CPU

The 2488H V5 supports two or four Intel® Xeon® Scalable processors (Skylake, Cascade Lake). If only two processors are configured, install them in the CPU 1 and CPU 2 sockets.

NOTE

- For details about the models of CPUs that can be purchased, see the Huawei Server Compatibility Checker or consult Huawei local sales representatives. The address of Huawei Server Compatibility Checker is <http://support.huawei.com/onlinetoolsweb/ftca/en>.
- CPUs on the same server must be of the same model.
- For details about CPUs, visit https://www.intel.com/content/www/us/en/homepage.html?_ga=2.177735788.892605408.1505119021-2038087524.1485138084.

6.2 Memory

Memory Configuration Rules

The 2488H V5 supports up to 24 DIMMs when equipped with two processors and supports up to 48 DIMMs when equipped with four processors.

Observe the following rules when configuring DIMMs:

1. At least one DIMM must be configured.

2. DIMMs of different types (RDIMMs and LRDIMMs) cannot be installed on one server.
3. Each channel supports a maximum of eight ranks.

 **NOTE**

A channel supports more than eight ranks for LRDIMMs, because a quad-rank LRDIMM generates the same electrical load as a single-rank RDIMM on a memory bus.

4. The maximum number of DIMMs to be installed on the server varies with the processor type, DIMM type, number of ranks, and operating voltage. For details, see **Maximum number of DIMMs** in the following tables.

 **NOTE**

Restriction of the number of ranks supported by each channel on the maximum number of DIMMs supported by each channel:

Number of DIMMs supported by each channel ≤ Number of ranks supported by each memory channel/Number of ranks supported by each DIMM

5. All DIMMs operate at the same speed, which is the smaller value of:
 - Memory speed supported by a CPU
 - Lowest maximum operating speed for the selected memory configuration. This speed varies with the rated speed, operating voltage, and number of DIMMs for each memory channel. For details, see **Maximum operating speed** in the following tables.

Table 6-1 Memory configuration rules for Intel® Xeon® scalable processors

Parameter		DIMM
Rank		Single Rank, Dual Rank, Quad Rank and Octal Rank
Rated speed (MT/s)		2933 ^c
Operating voltage (V)		1.2
Maximum number of DIMMs ^a		48
Maximum capacity per DIMM (GB)		128
Maximum memory capacity ^b (GB)		6144
Maximum operating speed (MT/s)	One DIMM per channel	2933 ^c
	Two DIMMs per channel	2666

Parameter	DIMM
<ul style="list-style-type: none"> ● a: The maximum number of DIMMs is based on 4-CPU configuration. If the server has only two CPUs, the maximum number of DIMMs is half the value in this table. ● b: The maximum memory capacity varies depending on the type of CPUs used. The maximum memory capacity in this table is calculated as the server is configured with 48 DDR4 DIMM. ● c: At present, only when Cascade Lake CPUs are configured, the rated speed and maximum working speed of DIMMs can reach 2933 MT/s. When Skylake CPUs are configured, the rated speed and maximum working speed of DIMMs are 2666 MT/s. ● This table is for reference only. For details about the components that can be purchased, consult the local Huawei sales representatives. 	

Memory Slot Configuration Rules

- The server provides 48 DDR4 DIMM slots. Each processor supports six memory channels and each memory channel supports two DDR4 DIMMs.
- A maximum of 48 DDR4 DIMMs are supported. The capacity of a single DDR4 DIMM can be 8 GB, 16 GB, 32 GB, 64 GB, or 128 GB. If DDR4 DIMMs are fully configured, the maximum capacity is 6144 GB.
- It is recommended that the CPUs in the 2488H V5 use the same DIMM configuration. The system performance deteriorates if the DIMM configurations of the CPUs are different.
- For details about the recommended DIMM configuration for each CPU of the 2488H V5, see [Table 6-2](#).

[Figure 6-1](#) shows the DIMM slots and their numbers.

Figure 6-1 DIMM slots

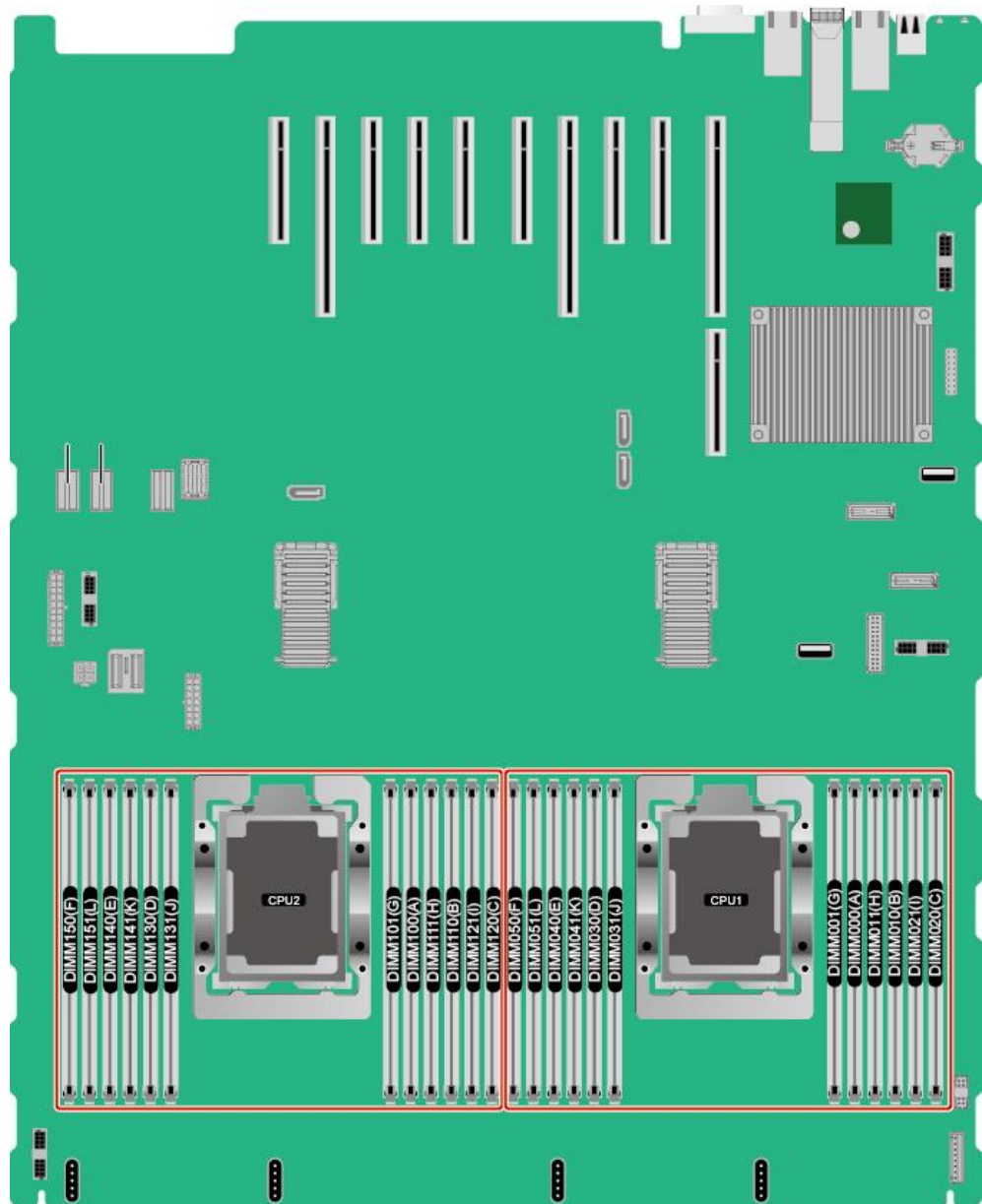

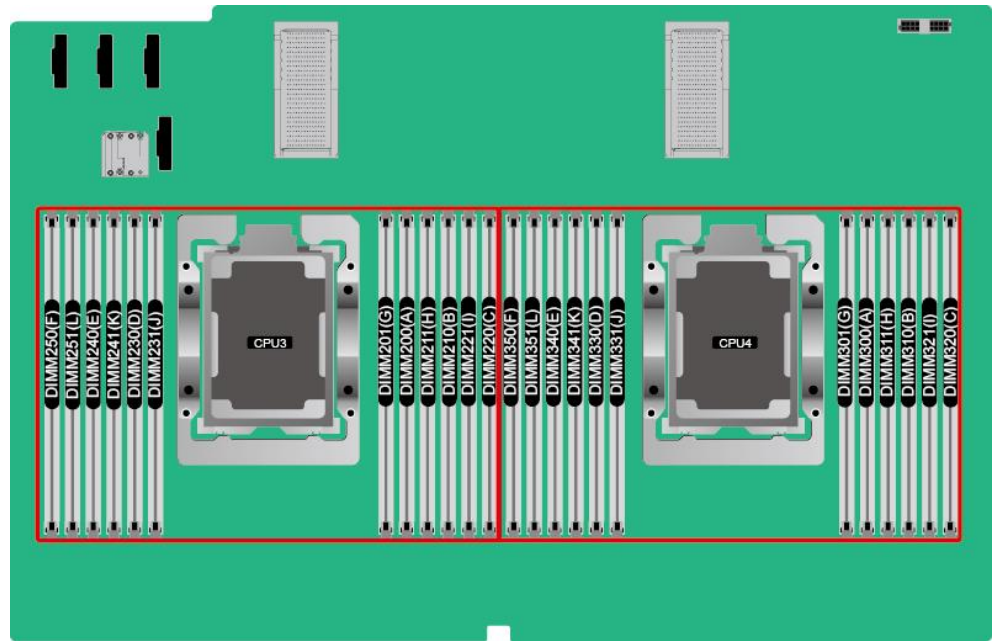

Table 6-2 lists the order in which the DIMMs are installed.

Table 6-2 Memory channel combinations and DIMM configuration rules

CPU Socket	Channel	DIMM	Number of DIMMs Supported by a CPU						
			1	2	3	4	6	8	12
CPU1	A	000(A)	●	●	●	●	●	●	●
		001(G)						●	●
	B	010(B)		●	●	●	●	●	●
		011(H)						●	●
	C	020(C)			●		●		●
		021(I)							●
	D	030(D)				●	●	●	●
		031(J)						●	●
	E	040(E)				●	●	●	●
		041(K)						●	●
F	050(F)					●		●	
	051(L)							●	
CPU2	A	100(A)	●	●	●	●	●	●	●
		101(G)						●	●
	B	110(B)		●	●	●	●	●	●

CPU Socket	Channel	DIMM	Number of DIMMs Supported by a CPU							
		111(H)							●	●
	C	120(C)			●			●		●
		121(I)								●
	D	130(D)				●	●	●	●	●
		131(J)							●	●
	E	140(E)				●	●	●	●	●
		141(K)							●	●
	F	150(F)						●		●
		151(L)								●
	CPU3	A	200(A)	●	●	●	●	●	●	●
201(G)									●	●
B		210(B)		●	●	●	●	●	●	●
		211(H)							●	●
C		220(C)			●			●		●
		121(I)								●
D		130(D)				●	●	●	●	●
		131(J)							●	●
E		140(E)				●	●	●	●	●
		141(K)							●	●
F	150(F)						●		●	
	151(L)								●	
CPU4	A	300(A)	●	●	●	●	●	●	●	●
		301(G)							●	●
	B	310(B)		●	●	●	●	●	●	●
		311(H)							●	●
	C	320(C)			●			●		●
		321(I)								●
	D	330(D)				●	●	●	●	●
		331(J)							●	●

CPU Socket	Channel	DIMM	Number of DIMMs Supported by a CPU						
			1	2	3	4	5	6	7
	E	340(E)				●	●	●	●
		341(K)						●	●
	F	350(F)					●		●
		351(L)							●

 **NOTE**

A single CPU configuring with 5, 7, 9, 10, or 11 DIMMs is asymmetrical DIMM configuration, which is not listed in the preceding table because the asymmetrical configuration will degrade the performance of the memory system. You are not advised to use such memory configuration.

Memory Protection Technologies

DDR4 DIMM supports the following memory protection technologies:

- Advanced ECC
- Memory mirroring
- SDDC
- ADDDC
- Rank sparing
- Lockstep

Supported DIMMs

 **NOTE**

- For details about component options, consult the local Huawei sales representatives or use the [Huawei Server Compatibility Checker](#).
- DIMMs on the same server must be of the same model.

6.3 Storage

The 2488H V5 supports the following types of drive configurations:

- 8 SAS/SATA drives
 The server supports a maximum of eight 2.5-inch front SAS/SATA drives. One standard PCIe RAID controller card is required.
- 25 SAS/SATA drives
 The server supports a maximum of twenty-five 2.5-inch front SAS/SATA drives. One standard PCIe RAID controller card is required.
- 24 SAS/SATA drives (pass-through)
 The server supports a maximum of twenty-four 2.5-inch front SAS/SATA drives. Three standard PCIe RAID controller cards are required. Each RAID controller card is directly connected to eight drives.

- 16 SAS/SATA drives + 8 NVMe SSDs
 The server supports a maximum of sixteen 2.5-inch front SAS/SATA drives with one standard PCIe RAID controller card required, and supports a maximum of eight 2.5-inch front NVMe SSDs with two NVMe adapters required. Each adapter supports four NVMe SSDs.
- 24 NVMe SSDs
 The server supports a maximum of twenty-four 2.5-inch front NVMe SSDs. Two NVMe adapters are required. Slots 0 to 3 can be configured with 2.5-inch SAS/SATA drives. In this case, two NVMe adapters and one plug-in PCIe RAID controller card need to be configured.

The following tables list the supported drives.

 **NOTE**

The following tables list only some typical component options. For details about component options, consult the local Huawei sales representatives.

Table 6-3 Supported SAS/SATA drives

BOM Number	Capacity	Description
02311HAN	300 GB	300GB-SAS 12Gb/s-10K rpm-2.5inch-128MB
02311EXX	300 GB	300GB-SAS 12Gb/s-15K rpm-2.5inch-128MB
02310YCH	1 TB	1000GB-SATA-7200rpm-2.5"-64M

Table 6-4 Supported SATA&SAS drives and NVMe SSDs

BOM Number	Capacity	Description
02311VHS	480 GB	Function Module,Servers,SSD,480GB,SATA 6Gb/s,Read Intensive,PM863a Series,2.5inch(2.5inch Drive Bay),LE Series
02311VHT	960 GB	Function Module,Servers,SSD,960GB,SATA 6Gb/s,Read Intensive,PM863a Series,2.5inch(2.5inch Drive Bay),LE Series
02311PPL	800 GB	Function Module,Servers,ES3500S V3 SSD, 800GB,SAS 12Gb/s,Read Intensive,1 DWPD, 2.5inch(2.5 inch Drive Bay),LE Series
02311WNM	1600 GB	Function Module,ES3620S V3,SSD,1600GB,SAS 12Gb/s,Mixed Use,3DWPD,2.5inch(2.5inch Drive Bay),VE Series
02311PNQ	1.8 TB	Function Module,Servers,ES3500P V3 SSD, 1800GB,NVMe PCIe,Read Intensive,1 DWPD, 2.5inch(2.5inch Drive Bay),LE Series,Tencent

BOM Number	Capacity	Description
02311MSC	2 TB	Function Module,Servers,ES3500P V3 SSD, 2000GB,NVMe PCIe,Read Intensive,1 DWPD, 2.5inch(2.5inch Drive Bay)
02311MSE	3.2 TB	Function Module,Servers,ES3500P V3 SSD, 3200GB,NVMe PCIe,Read Intensive,1 DWPD, 2.5inch(2.5inch Drive Bay)

Table 6-5 lists the supported standard PCIe RAID controller cards.

 **NOTE**

Table 6-5 lists only some typical component options. For details about component options, consult the local Huawei sales representatives or use the [Huawei Server Compatibility Checker](#).

Table 6-5 Supported standard PCIe RAID controller cards

BOM Number	Chip	Description	Vendor	Remarks
02311WMX	LSI SAS3108	Function Module,2488H V5,BC6M02RAID,AVAGO936 1 PCIe RAID Controller,RAID0, 1, 5, 6, 10, 50, 60,1GB cache,PCIe 3.0 X8,used for 8HDD	Broadcom	Note1
02311WMY	LSI SAS3108	Function Module,2488H V5,BC6M01RAID,AVAGO936 1 PCIe RAID Controller,RAID0,1,5,6,10,50,60,1GB cache,PCIe 3.0 X8,used for 25HDD	Broadcom	Note1
02311XJF	LSI SAS3108	Function Module,2488H V5,BC6M03RAID,AVAGO936 1 PCIe RAID Controller,RAID0, 1, 5, 6, 10, 50, 60,1GB cache,PCIe 3.0 X8,used for 8NVME+16HDD	Broadcom	Note1
02311YFU	/	Function Module,Server,BC1M01TFM,LSI Flash Card-4GB,TFM, Supercapacitor and 620mm Cable Module	Broadcom	Provides a supercapacitor to protect data in the case of power failures.

BOM Number	Chip	Description	Vendor	Remarks
Note 1: If a supercapacitor for power-off protection is required, select 02311YFU.				

Table 6-6 describes the comparison between RAID levels in the performance, minimum number of drives, and drive usage.

Table 6-6 RAID level comparison

RAID Level	Reliability	Read Performance	Write Performance	Minimum Number of Drives	Drive Usage
RAID 0	Low	High	High	2	100%
RAID 1	High	Low	Low	2	50%
RAID 5	Relatively high	High	Medium	3	(N - 1)/N
RAID 6	Relatively high	High	Medium	4	(N - 2)/N
RAID 10	High	Medium	Medium	4	50%
RAID 50	High	High	Relatively high	6	(N - M)/N
RAID 60	High	High	Relatively high	8	(N - M x 2)/N
Note: N indicates the number of member drives in a RAID group, and M indicates the number of subgroups in a RAID group.					

6.4 I/O Expansion

The server supports a wide range of PCIe cards for you to choose based on the card type and transmission speed:

- Fiber Channel (FC) host bus adapter (HBA)
- Converged network adapter (CNA)
- InfiniBand (IB) expansion card
- SAS HBA
- Network expansion card
- SSD card
- GPU card

The following tables list the PCIe cards supported by the server.

 **NOTE**

The typical component options are for reference only. For details about component options, consult the local Huawei sales representatives or use the [Huawei Server Compatibility Checker](#).

Table 6-7 Supported standard PCIe cards (FC HBAs)

BOM Number	Model	Description	API Type	Vendor	Remarks
06030382	QLE2692	Other Cards,HBA Card QLE2692-HUA-SP,FC Double Ports-16Gb/s,PCIE 3.0 x8-Vendor ID 1077-Device ID 2261-2,Multimode optical module,half width half length	SFP+	QLogic	Note 1
06030381	QLE2690	Other Cards,HBA Card QLE2690-HUA-SP,FC Single Port-16Gb/s,PCIE 3.0 x8-Vendor ID 1077-Device ID 2261-1,Without Doc,Multimode optical module,half width half length	SFP+	QLogic	Note 1
Note: 1. The compatibility information released by third-party vendors prevails. To download drivers, visit third-party websites. 2. The server provides SFP+ Optics.					

Table 6-8 Supported standard PCIe cards (IB expansion cards)

BOM Number	Model	Description	API Type	Vendor	Remarks
06030284	MCX354A	Other Cards,Infiniband MCX354A-FCBT,FDR Dual port-56Gb/s,PCIE 3.0 X8-Vendor ID 15b3-Device ID 1003-1,English doc,half width half length	QSFP	QLogic	Note 1

BOM Number	Model	Description	API Type	Vendor	Remarks
Note: The compatibility information released by third-party vendors prevails. To download drivers, visit third-party websites.					

Table 6-9 Supported standard PCIe cards (NICs)

BOM Number	Model	Description	API Type	Vendor	Remarks
02311CWM	I350	Function Module,Server,CN2 1ITGC01,Intel I350 4*GE Half-height Half-length ,Full Handle bars,Ethernet Card,PCIE 2.0 X4-Vendor ID 8086-Device ID 1521-4	RJ45	Intel	Note 1
02311MSP	X540	Function Module,Rack Server,CN2M01ITGD,Ethernet Adapter, 10Gb Electrical Interface(Intel X540),2-Port,RJ45,PCIe 2.0 x8	SFP+	Intel	Note 1
02311PXA	X550	Function Module,Rack Server,CN2M01ITGE,Ethernet Adapter, 10Gb Electrical Interface(Intel X550),2-Port,RJ45,PCIe 2.0 x8	SFP+	Intel	Note 1

BOM Number	Model	Description	API Type	Vendor	Remarks
02311RM W	X710	Function Module,Rack Server,CN2M01ITG G,Ethernet Adapter, 10Gb Optical Interface(Intel X710),2-Port,SFP+ (without Optical Transceiver),PCIe 3.0 x8	SFP+	Intel	Note 1
02311RM Y	XL710	Function Module,Rack Server,CN2M02ITG H,Ethernet Adapter, 10Gb Optical Interface(Intel XL710),4-Port,SFP+(without Optical Transceiver),PCIe 3.0 x8	SFP+	Intel	Note 1
Note: The compatibility information released by third-party vendors prevails. To download drivers, visit third-party websites.					

Table 6-10 Supported standard PCIe cards (PCIe SSDs)

BOM Number	Model	Description	API Type	Vendor
02311SHA	ES3600C	Function Module,ES3000 V3,HWE36P43008M000N,ES3600C-800GB-3 DWPD-PCIE 3.0 X4-Vendor ID 19e5-Device ID 0123-1,Model number HWE36P43008M000N,HH/HL Card,NVMe SSD	PCIe 3.0	Huawei

BOM Number	Model	Description	API Type	Vendor
02311PBJ	ES3600C	Function Module,ES3000 V3,CN2M10FACP,ES3600C-3200GB-3 DWPD-PCIE 3.0 X4- Vendor ID 19e5- Device ID 0123-1,Model number HWE36P43032M000N ,HH/HL Card,NVMe SSD	PCIe 3.0	Huawei

6.5 PSU

Table 6-11 lists the PSU supported by the server.

 **NOTE**

- **Table 6-11** is for reference only. For details about component options, consult the local Huawei sales representatives or use the [Huawei Server Compatibility Checker](#).
- A server must use PSUs of the same model.

Table 6-11 Supported PSUs

BO M Nu mbe r	Rated Power	Power Input	Power Output	Energy Efficiency Grade	Altitude
02131336	1500 W	200 V-240 V/6.8 A	+12 V/125 A 94.0%	Platinum	5000 m
02312DAE	1500W	100-127V AC/12.5A; 200-240V AC/10A; 240V DC/8A;	12.1V/82.7A;1000W; 12V/125A;1500W; 12V/125A;1500W;	Platinum	5000m
02311TLF	900W	100-240V AC/11~5.5A; 240V DC/5A;	+12V/75A;900W; +12V/75A;900w;	Platinum	5000m
02312GEN	1200W -48V DC_Power_Supply Module	-48V- -60V DC/32A;	12V/100A;1200W;	Gold	5000m

BO M Nu mbe r	Rated Power	Power Input	Power Output	Energy Efficienc y Grade	Altitu de
0231 2AH K	2000W	220-240V AC/ 10A; 240V DC/10A; 200~220V AC/ 10A;	+12V/167A;2000W; +12V/167A;2000W; +12V/150A;1800W;	Platinum	5000m
0231 2GE Q	1500W HVDC_P ower_Sup ply Module	260 - 400V DC/8A; 200 - 277V AC/ 10A;	12V/125A;1500W; 12V/125A;1500W;	Platinum	5000m

6.6 OS and Software Support

Use the [Huawei Server Compatibility Checker](#) to check the components supported.

7 System Management

The server uses Huawei's proprietary Intelligent Baseboard Management Controller (iBMC) to implement remote server management. The iBMC complies with Intelligent Platform Management Interface (IPMI) 2.0 and provides highly reliable hardware monitoring and management.

The iBMC supports the following features and protocols:

- KVM and text console redirection
- Remote virtual media
- IPMI
- Simple Network Management Protocol (SNMP)
- Login using a web browser
- Redfish

Table 7-1 describes the features of the iBMC.

Table 7-1 iBMC features

Feature	Description
Management interface	Integrates with any standard management system through the following interfaces: <ul style="list-style-type: none">● IPMI● CLI● HTTPS● SNMP● Redfish
Fault detection	Detects faults and accurately locates faults in hardware, for example, an FRU.
Alarm management	Supports alarm management and reports alarms using the SNMP trap, Simple Mail Transfer Protocol (SMTP), and syslog service to ensure 24/7 continuous operation.

Feature	Description
Integrated virtual KVM	Provides remote maintenance measures and VNC services for troubleshooting and supports a maximum resolution of 1920 x 1200.
Integrated virtual media	Virtualizes local media devices, images, USB keys, and folders into media devices on a remote server, simplifying OS installation. (The virtual DVD-ROM drive supports a maximum transmission rate of 8 MB/s.)
WebUI	<p>Provides a user-friendly graphical user interface (GUI), which simplifies users' configuration and query operations.</p> <p>The iBMC WebUI supports OSs, web browsers, and JRE of the following versions:</p> <ul style="list-style-type: none"> ● Windows 7 32-bit/64-bit: Internet Explorer 9/10/11, Mozilla Firefox 26/34, or Google Chrome 21/39; JRE 1.6.0 U25/1.7.0 U40/1.8.0 U45 or later ● Windows 8 32-bit/64-bit: Internet Explorer 9/10/11, Mozilla Firefox 26/34, or Google Chrome 21/39; JRE 1.6.0 U25/1.7.0 U40/1.8.0 U45 or later ● Windows Server 2008 R2 32-bit/64-bit: Internet Explorer 9/10/11, Mozilla Firefox 26/34, or Google Chrome 21/39; JRE 1.6.0 U25/1.7.0 U40/1.8.0 U45 or later ● Windows Server 2012 R2 32-bit/64-bit: Internet Explorer 9/10/11, Mozilla Firefox 26/34, or Google Chrome 21/39; JRE 1.6.0 U25/1.7.0 U40/1.8.0 U45 or later ● Red Hat Enterprise Linux 6.0 64-bit: Mozilla Firefox 26/34; Google Chrome 21/39; JRE 1.6.0 U25/1.7.0 U40/1.8.0 U45 or later ● MAC: Safari 5.1; Mozilla Firefox 26/34; JRE 1.6.0 U25/1.7.0 U40/1.8.0 U45 or later
Fault reproduction	Reproduces faults to facilitate fault diagnosis.
Screen snapshots and screen videos	Allows you to view screenshots and videos without login, which facilitates routine preventive maintenance inspection (PMI)
Domain Name Service (DNS)/ Active Directory (AD)	Supports the DNS and AD, significantly simplifying network and configuration management.
Dual-image backup	Starts software from a backup image if the software fails.
Asset management	Supports intelligent asset management to manage and check assets being used in a unified manner.

Feature	Description
Intelligent power management	Uses the power capping technology to increase deployment density, and uses dynamic energy saving to lower operating expenses.
IPv6	Supports IPv6 to help build an all-IPv6 environment.
Network Controller Sideband Interface (NC-SI)	Supports NC-SI, which allows you to access the iBMC through the service network port.

8 Warranty

According to the *Huawei Warranty Policy for Servers & Storage Products* (*Warranty Policy* for short), Huawei provides a three-year warranty for the server, a one-year warranty for DVD-ROM drives and iBBUs, and a three-month warranty for software media.

The *Warranty Policy* stipulates warranty terms and conditions, including the available services, response time, terms of service, and disclaimer.

The warranty terms and conditions may vary by country, and some services and/or parts may not be available in all countries. For more information about warranty services in your country, contact Huawei technical support or the local Huawei representative office.

9 Certifications

No.	Country/ Region	Certification	Standards
1	China	RoHS	SJ/T 11363—2006 SJ/T 11364—2006 GB/T 26572—2011
2	China	CCC	GB4943.1-2011 GB9254-2008(Class A) GB17625.1-2012

No.	Country/ Region	Certification	Standards
3	Europe	CE	Safety: IEC 60950-1:2005(2nd Edition)+A1:2009 and/or EN 60950-1:2006+A11:2009+A1:2010+ A12:2011 EMC: EN 55022:2010 CISPR 22:2008 EN 55024:2010 CISPR 24:2010 ETSI EN 300 386 V1.6.1:2012 ETSI ES 201 468 V1.3.1:2005 IEC 61000-3-2:2005+A1:2008+A2:2009/EN 61000-3-2:2006+A1:2009+A2:2009 IEC 61000-3-3:2008/EN 61000-3-3:2008 IEC 61000-6-2:2005/EN 61000-6-2:2005 IEC 61000-6-4:2006+A1:2010/EN 61000-6-4:2007+A1:2011 RoHS: 2002/95/EC, 2011/65/EU, EN 50581: 2012 REACH: EC NO. 1907/2006 WEEE: 2002/96/EC, 2012/19/EU
4	America	FCC	FCC CFR47 Part 15:2005 Class A
5	America	Energy Star	ENERGY STAR® Program Requirements for Computer Servers
6	Canada	IC	ICES-003:2004 Class A
7	Australia	C-tick	AS/NZS CISPR 22:2009
8	Japan	VCCI	VCCI V-3:2012
9	Saudi	SASO	IEC 60950-1: 2005 (2nd Edition) + A1:2009 EN 60950-1:2006+A11:2009+A1:2010 + A12:2011
10	Nigeria	SONCAP	IEC 60950-1: 2005 (2nd Edition) + A1:2009 EN 60950-1:2006+A11:2009+A1:2010 + A12:2011

No.	Country/ Region	Certification	Standards
11	Kuwait	Kucas	IEC 60950-1: 2005 (2nd Edition) + A1:2009 EN 60950-1:2006+A11:2009+A1:2010 + A12:2011

10 Nameplate Models

Certified Model	Remarks
H24H-05	Global model
H24H-05-I20	For India only